

Signum SG1X EVO TG ARGB

Accessories / Dołączone akcesoria

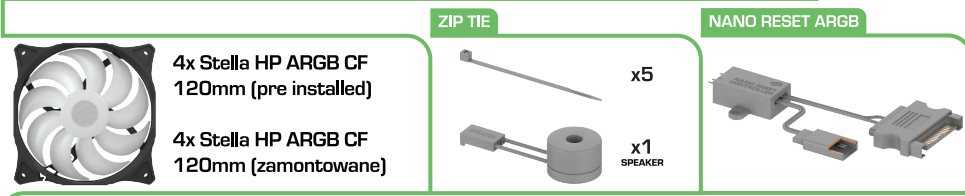
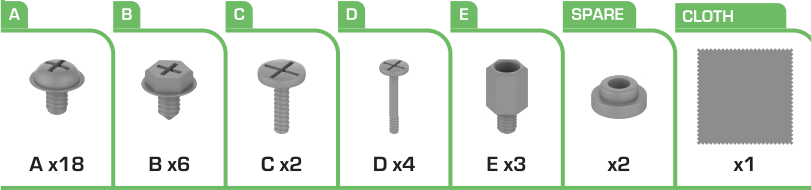

PANEL I/O

1. USB ports/
Wejścia USB
2. Microphone port/
Wtyczka mikrofonu
3. Headphone port/
Wtyczka słuchawek
4. HDD, SSD LED/
Dioda HDD, SSD
5. LED/Reset button/
Przycisk LED/Reset
6. Power button/
Przycisk zasilania

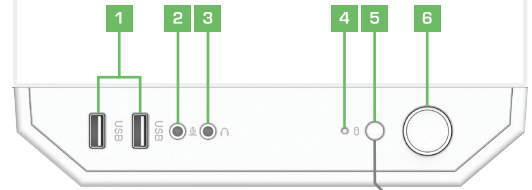

1. Overview / Przegląd

REAR / TYŁ



TOP FILTER / FILTR GÓRNY

TOP / GÓRA

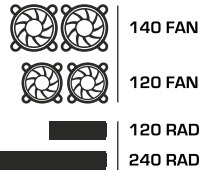

PSU FILTER / FILTR ZASILACZA

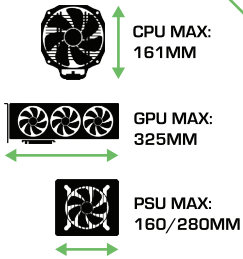

FRONT FILTERS / FILTRY PRZEDNIE

PSU CHAMBER / KOMORA ZASILACZA



FRONT / PRZÓD



2. Panel removal / Zdejmowanie paneli



ARGB and FAN Splitter/ Rozgałęziacz złącz ARGB oraz zasilania wentylatorów

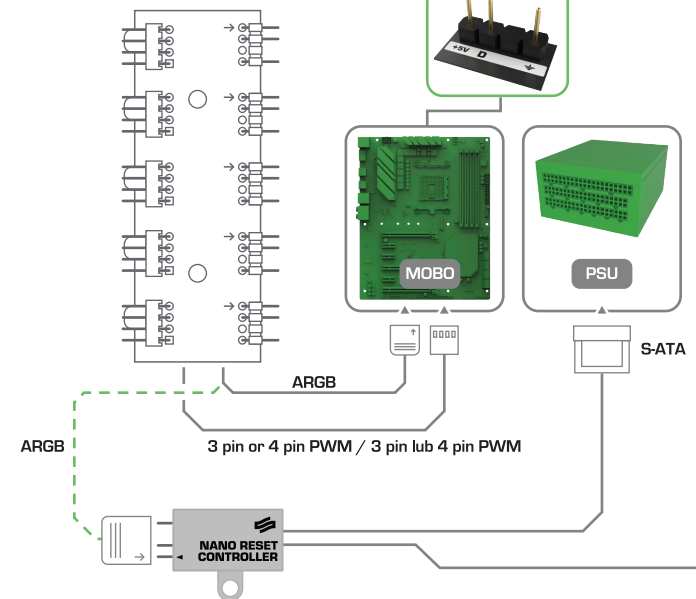

i EN: If motherboard without ARGB connector use Nano Reset ARGB controller/
PL: Jeśli płyta główna nie posiada złącz ARGB, podłącz do kontrolera Nano Reset ARGB

3. Hardware installation / Montaż sprzętu

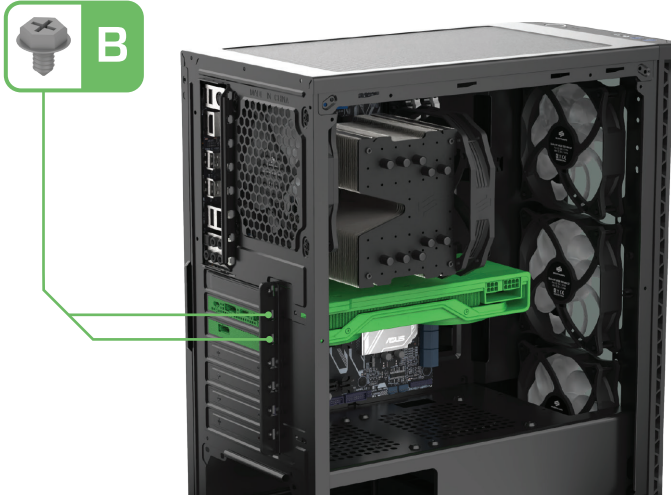
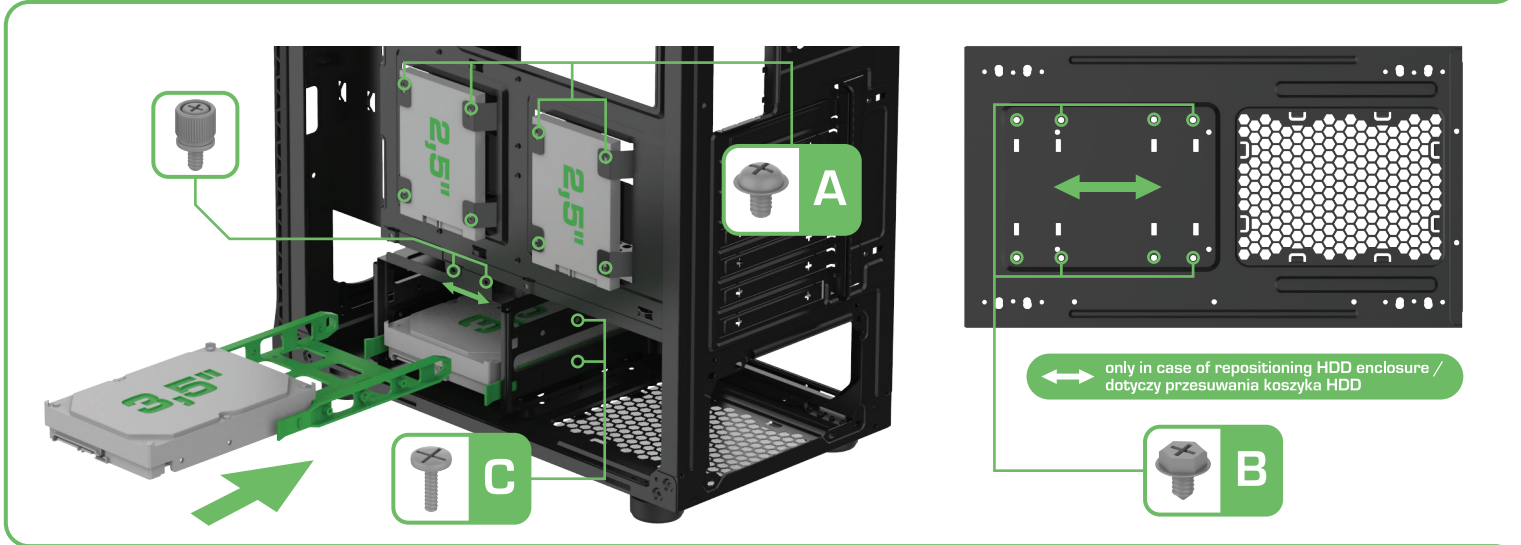
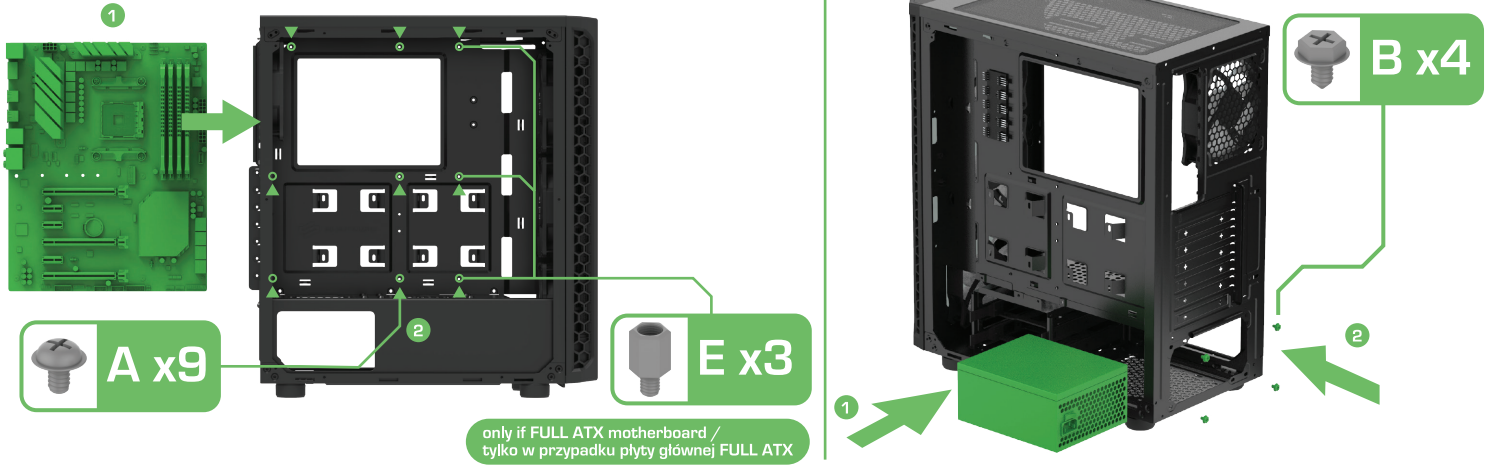

4. Front panel removal / Zdejmowanie panela przedniego



5. Dust filters / Filtry przeciwkurzowe

