

# NAVIS 120 PRO

INSTALACJA / INSTALLATION / MONTAGE

AMD AM2 / AM2+ / AM3 / AM3+ / FM2

PL: Przygotuj zestaw montażowy jak na zdjęciu i dopasuj punkty #

EN: Prepare the parts listed below and match the steps #

DE: Bitte bereiten Sie alle Teile zur Montage vor (wie auf dem Abbild unten).

Die entsprechenden Schritte und Teile sind mit dem entsprechenden # und Nummer versehen.

Video manual:

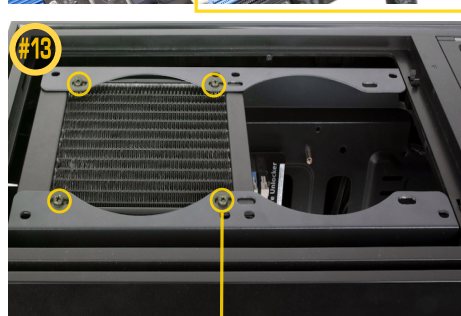
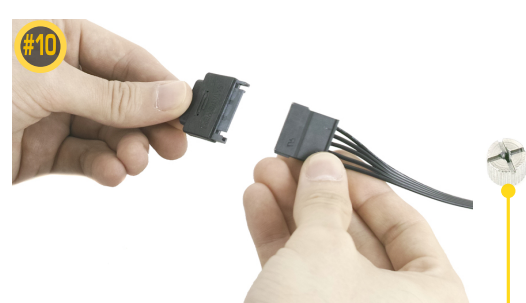
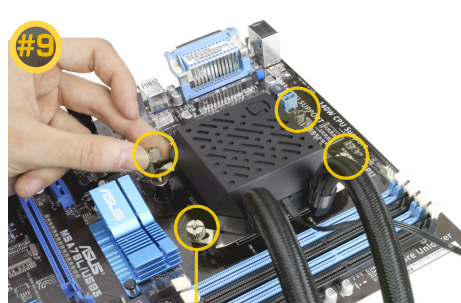
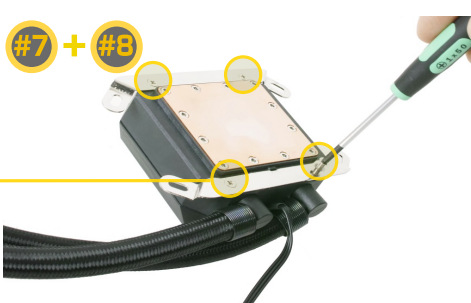
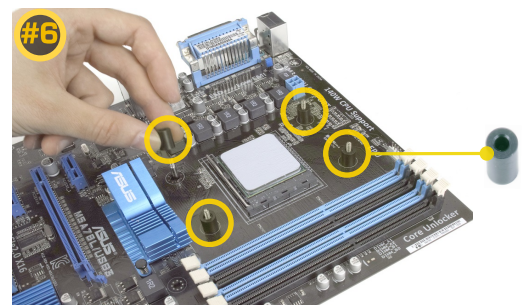
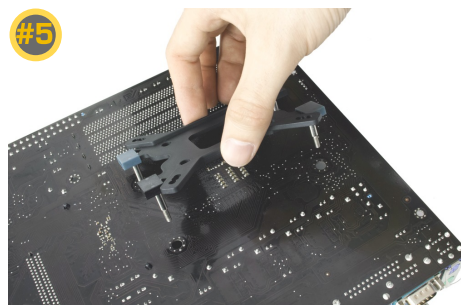
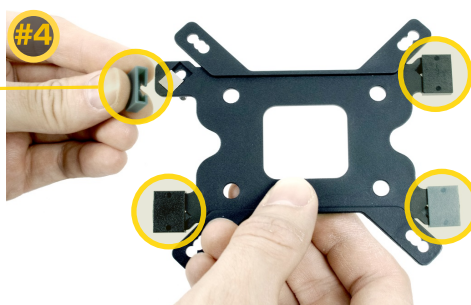
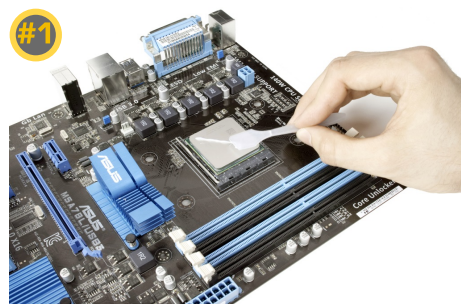
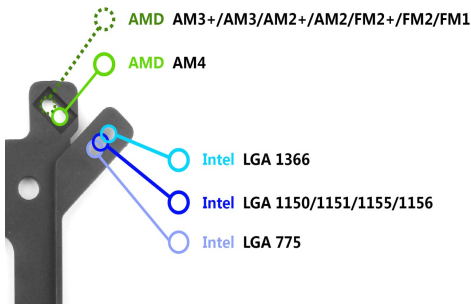
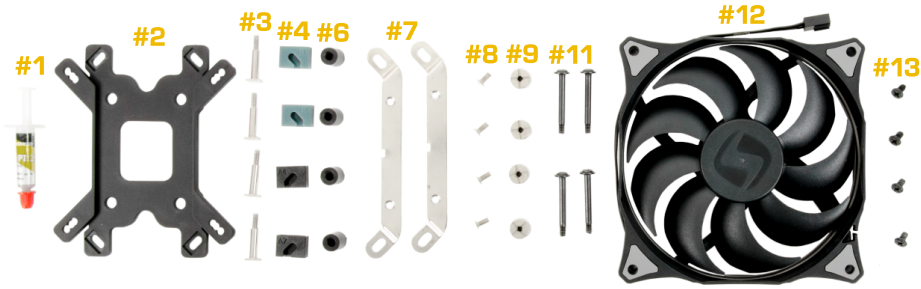

PL: Przygotuj zestaw montażowy jak na zdjęciu i dopasuj punkty #

EN: Prepare the parts listed below and match the steps #

DE: Bitte bereiten Sie alle Teile zur Montage vor (wie auf dem Abbild unten).

Die entsprechenden Schritte und Teile sind mit dem entsprechenden # und Nummer versehen.

Video manual:

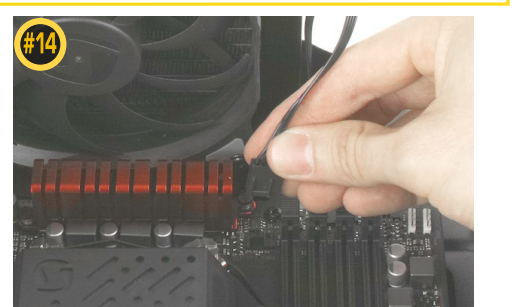
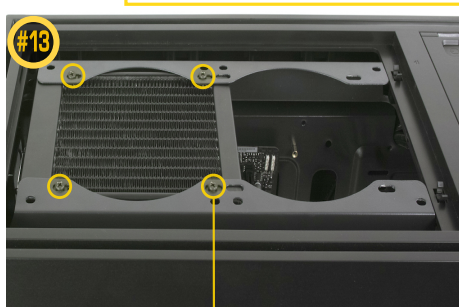
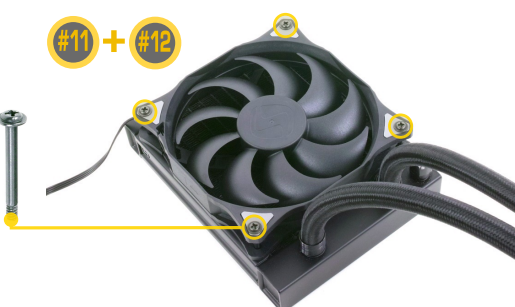
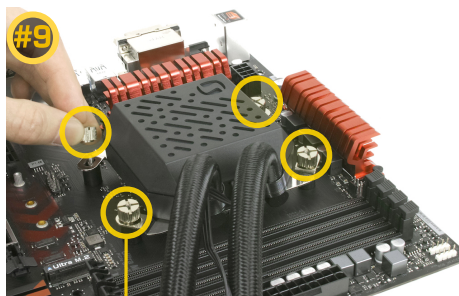
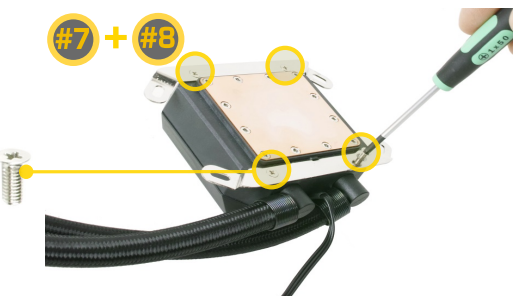
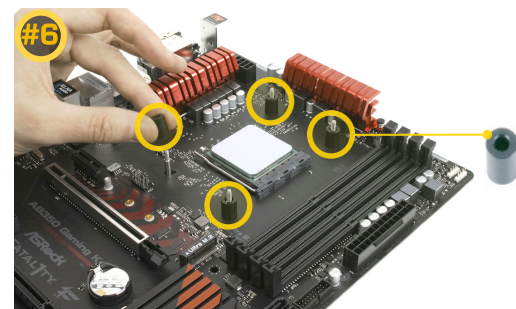
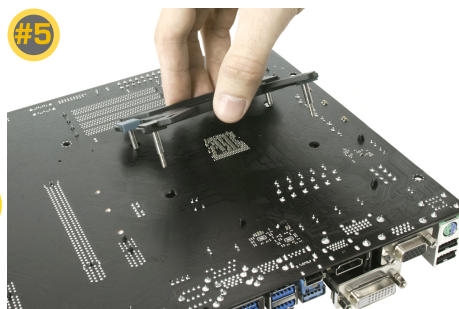
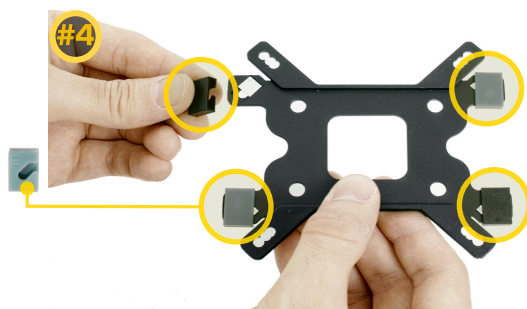
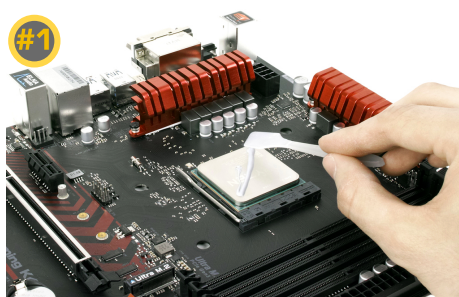
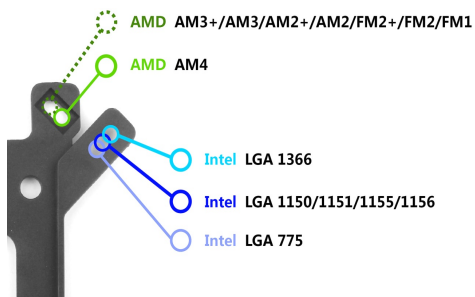
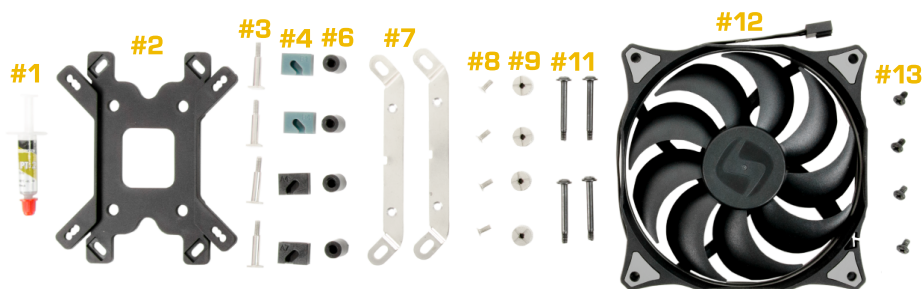

# NAVIS 120 PRO

INSTALACJA / INSTALLATION / MONTAGE

INTEL LGA 775 / 1150 / 1151 / 1155 / 1156 / 1366

PL: Przygotuj zestaw montażowy jak na zdjęciu i dopasuj punkty #

EN: Prepare the parts listed below and match the steps #

DE: Bitte bereiten Sie alle Teile zur Montage vor (wie auf dem Abbild unten).

Die entsprechenden Schritte und Teile sind mit dem entsprechenden # und Nummer versehen.

Video manual:

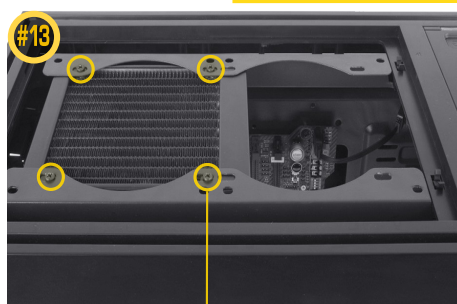
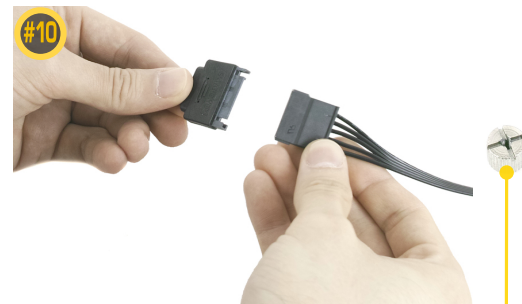
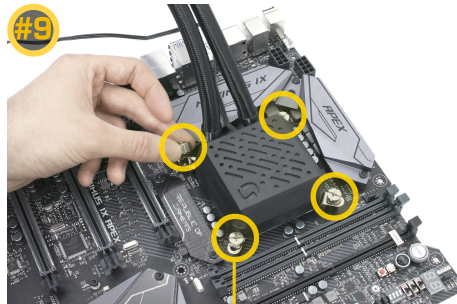
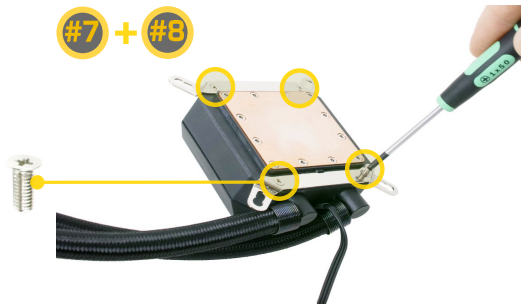
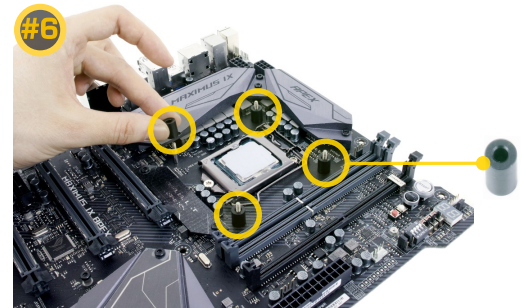
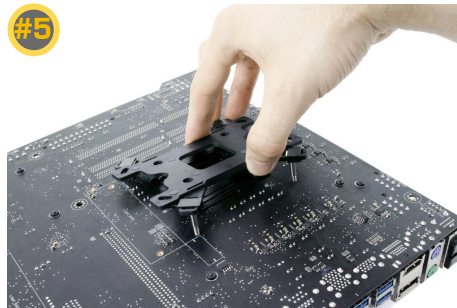
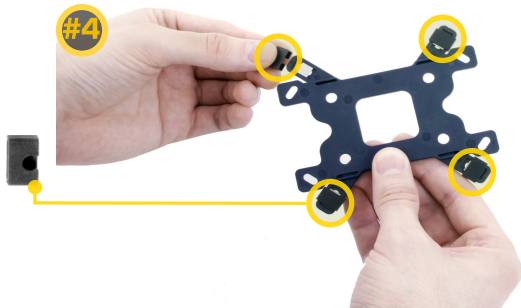
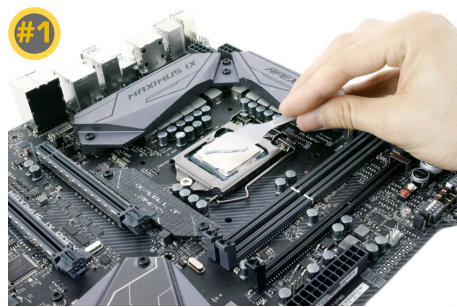
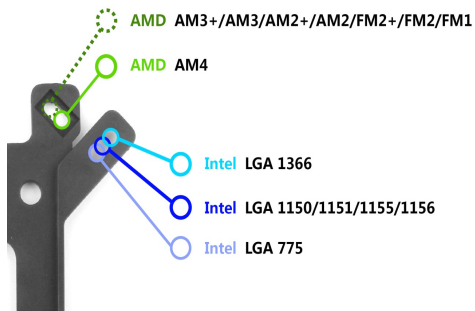
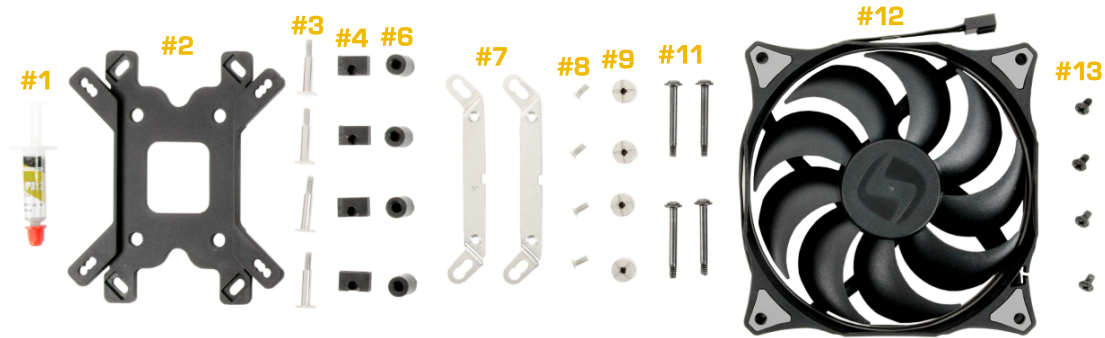

# NAVIS 120 PRO

INSTALACJA / INSTALLATION / MONTAGE

INTEL

LGA 2011 / 2011-3 / 2066

PL: Przygotuj zestaw montażowy jak na zdjęciu i dopasuj punkty #

EN: Prepare the parts listed below and match the steps #

DE: Bitte bereiten Sie alle Teile zur Montage vor (wie auf dem Abbild unten).

Die entsprechenden Schritte und Teile sind mit dem entsprechenden # und Nummer versehen.

Video manual:

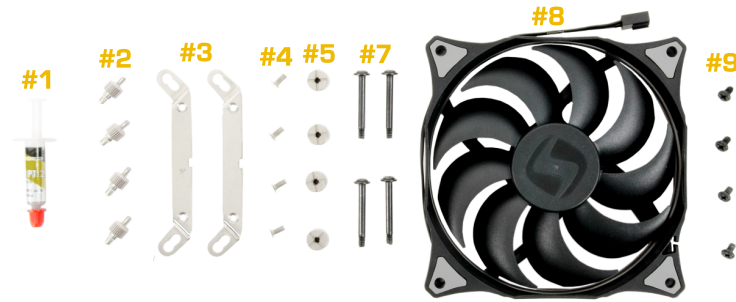

**LGA 2011 / 2011-3 / 2066**

**Montaż bez backplate'u**

**No backplate needed**

