



MANTA

LED TV

LED220Q7

Instrukcja obsługi / User's manual

Table of Contents

Safety warning	1
Important Safety Precautions	2
Preparation for Your New TV	3
TV Jacks Explanation	4
Side Keypad and Front Panel	5
Remote Control Instructions	6
Learning about Remote Control	7
TV OPERATION AND SYSTEM SETUP	8
Function Description	10
Picture Menu	10
SOUND Menu	12
APPLICATIONS	14
PREFERENCES	19
SETUP	21
Multimedia	23
MEDIA OPERATION	23
Photo	24
Movie	25
Music	26
Setup	27
How to use Record	28
Help	36
Product fiche	37

Safety warning



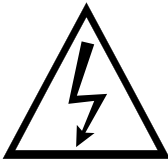

High voltages are used in the operation of this product. To reduce the risk of electric shock, do not remove cover of the cabinet, refer servicing to qualified service personnel.

If the TV any changes or coarse adjustment, electric shocks to be hurt, do not attempt to open a machine-maintenance, customer contact centres needed overhaul.

	<p>The exclamation point within an equilateral triangle is intended to alert the user to the presence of important operating instructions in the literature accompanying the appliance.</p>
	<p>Warning The lightning flash with arrowhead symbol within an equilateral triangle, is intended to alert the user to the presence of uninsulated dangerous voltage within the product's enclosure that may be of sufficient magnitude to constitute a risk of electric shock to persons.</p>

- minimum distances around the apparatus for sufficient ventilation;
- the ventilation should not be impeded by covering the ventilation openings with items, such as newspapers, table-cloths, curtains, etc.;
- attention should be drawn to the environmental aspects of battery disposal;
- the use of apparatus in moderate climates.

Important Safety Precautions

1. Read these instructions.
2. Keep these instructions.
3. Heed all warnings.
4. Follow all instructions.
5. Do not use this apparatus near water.
6. Clean only with dry cloth.
7. Do not block any ventilation openings. Install in accordance with the manufacturer's instructions.
8. Do not install near any heat sources such as radiators, heat registers, stoves, or other apparatus (including amplifiers) that produce heat.
9. Do not defeat the safety purpose of the polarized or grounding-type plug. A polarized plug has two blades with one wider than the other. A grounding type plug has two blades and third grounding prong. The wide blade or third prong are provided for your safety. When the provided plug does not fit into your outlet, consult an electrician for replacement of the obsolete outlet.
10. Protect the power cord from being walked on or pinched, particularly at plugs, convenience receptacles, and the point where they exit from the apparatus.
11. Only use attachments/accessories specified by the manufacturer.
12.  Use only with the cart, stand, tripod, bracket, or table specified by the manufacturer, or sold with the apparatus. When a cart is used caution when moving the cart/apparatus combination to avoid injury tip-over.
13. Unplug this apparatus during lightning storms or when unused for long periods of time.
14. Refer all servicing to qualified service personnel. Servicing is required when the apparatus has been damaged in any way, such as power-supply cord or plug is damaged, liquid has been spilled or objects have fallen into the apparatus, the apparatus has been exposed to rain or moisture, does not operate normally, or has been dropped. Warning to reduce the risk of fire or electric shock, do not expose this apparatus to rain or moisture.
15. The apparatus shall be disconnected from the mains by placing the power/standby switch in the standby position and unplugging the power cord of the apparatus from the AC mains receptacle.
16. The socket-out shall be installed near the equipment and shall be easily accessible.
17. This product should never be placed in a built-in installation such as a bookcase or rack unless proper ventilation is provided or the manufacturer's instructions have been adhered to.
18. Apparatus shall not be exposed to dripping or splashing.
19. Do not place any sources of danger on the apparatus (e.g. liquid filled objects, lighted candles).
20. Wall or Ceiling Mounting - The appliance should be mounted to a wall or ceiling only as recommended by the manufacturer.
21.  Never place the TV, remote control or batteries near naked flames or other heat sources, including direct sunlight. To prevent the spread of fire, keep candles or other flames away from the TV, remote control and batteries at all times.
22. The USB terminal should be loaded with 0.5 A under normal operation.

Preparation for Your New TV

The TV is packaged with the TV stand separated from the cabinet. To setup the TV table stand, please carry out the installation according to the instructions below.

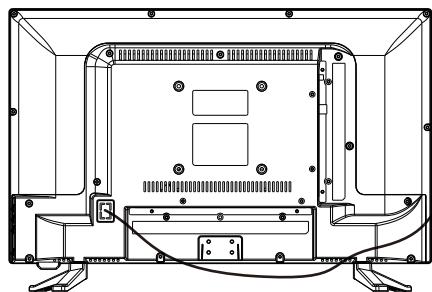

Step One

Place the TV faced down on a soft cloth or cushion to prevent the panel from being damaged

The panel can be scratched easily, so please:

1. Choose an absolutely flat surface to place the TV on.
2. Use soft cloth or cushion to face the TV panel, Do not put TV on the table directly.

Always unplug the AC cord first when installing/removing the stand.

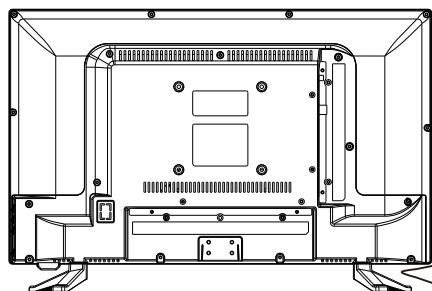

Step Two

Take the base. Please align the screw holes of the base and the TV, and then insert the 4 screws into the 4 holes on the base and tighten them.

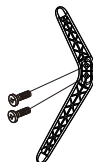

Pedestal Screws	Quantity
M4x12mm	4pcs



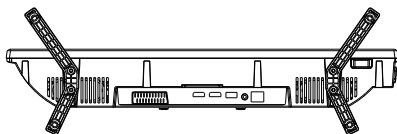





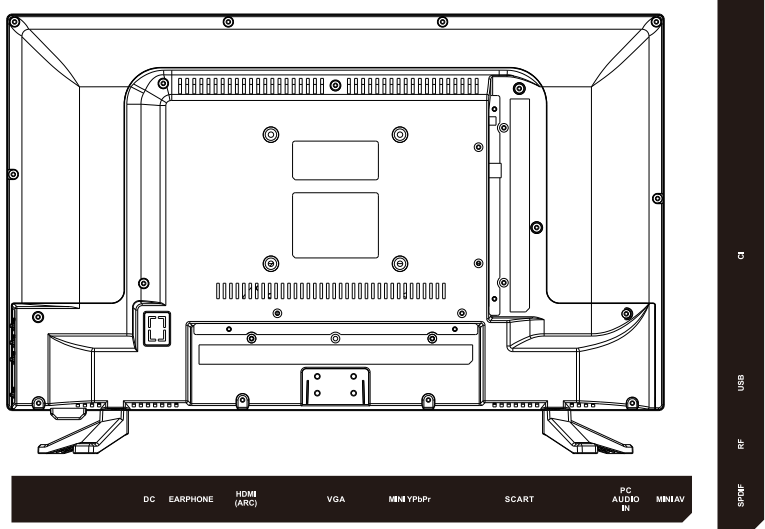



Please take note of the base direction:



The bottom view of the TV (Front cabinet faces down)

TV Jacks Explanation



 <p>DC</p>	<p>DC Connect the power cord of DC in.</p>	 <p>PC AUDIO INPUT</p>	<p>PC AUDIO INPUT VGA input and audio input when VGA input</p>
 <p>EARPHONE</p>	<p>EARPHONE output When earphones are plugged in, speakers are disabled</p>	 <p>AV INPUT</p>	<p>AV input External AV Signal Input And Relevant Right/Left Sound Channel</p>
 <p>HDMI</p>	<p>HDMI input Digital signal input from HDMI video connector.</p>	 <p>SPDIF</p>	<p>SPDIF Connect the SPDIF receiver.</p>
 <p>VGA</p>	<p>VGA input PC analog signal input</p>	 <p>RF</p>	<p>RF Connect the antenna</p>
 <p>INPUT</p>	<p>Y Pb Pr input Connect to the composite terminal of your DVD/VCR (Some models without this interface)</p>	 <p>USB</p>	<p>USB input Connect a USB device here to play its media files or to record programs via the PVR function.</p>
 <p>SCART</p>	<p>SCART input standard, it supports composite and RGB signal input. It is a connection for European (Some models without this interface)</p>	 <p>CI</p>	<p>CI SLOT The card reader input CI (common interface) this requires CAM (conditional access module) used for pay TV.</p>

Side Keypad and Front Panel

Keypad Buttons

If you cannot locate your remote, you can use the side keypad buttons on your TV to operate many TV features.

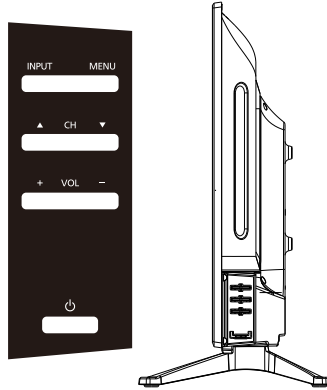

INPUT: Displays the Source Select List.

MENU: Displays the TV Main Menu.

CH▲: Scans up through the channel list. In the TV menu system, it acts like the up arrow on the remote control and can be used to select menu options.

CH▼: Scans down through the channel list. In the TV menu system, it acts like the down arrow on the remote control and can be used to select menu options.

VOL+: Increases the volume. In the TV menu system, it acts like the right arrow on the remote control and can be used to select menu options.

VOL-: Decreases the volume. In the TV menu system, it acts like the left arrow on the remote control and can be used to select menu options.

POWER (⏻): Turns the TV on and off.

Front Panel

About remote control working distance and angle, see next page.

Power/Standby Indicator: Blue and red dual-color LED. It shows red when the TV is turned off and blue when turned on. **Remote Control Sensor:** Remote control IR sensor, which receives infrared ray sent by remote control.

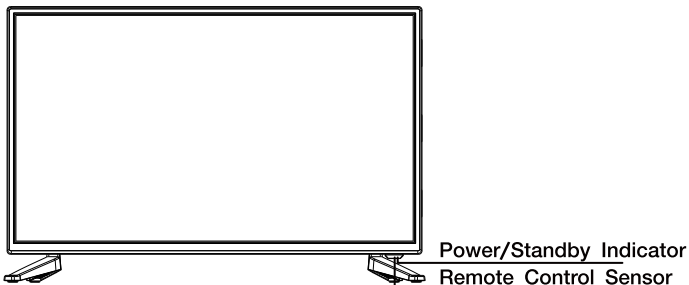

Remote Control Instructions

Inserting Batteries in the Remote

1. Remove the battery compartment cover from the back of the remote control by lifting the cover.
2. Insert 2AAA batteries ,making sure the polarities(+and-) are aligned correctly.
3. Replace the cover.

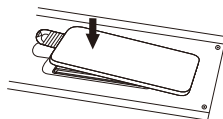
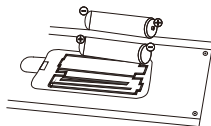
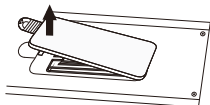

If the remote control does not work, check these points:

- Are the polarities (+, -) correct?
- Are the batteries worn out?
- Is there an AC power failure?
- Is the power cord plugged in?
- Is there any interference or block near the remote control sensor?

CAUTION:

- Used batteries should be recycled.
- Keep out of children's reach.
- DO NOT use new and old batteries together.
- Change both the batteries at the same time.
- When not using the remote control for a long time, remove the batteries from the unit.

Warning: All batteries (packed or in use) must not be exposed to high temperature like sun heat or fire.

Remote Control Reception Angle

Use your remote control within the distance and angle range shown below.

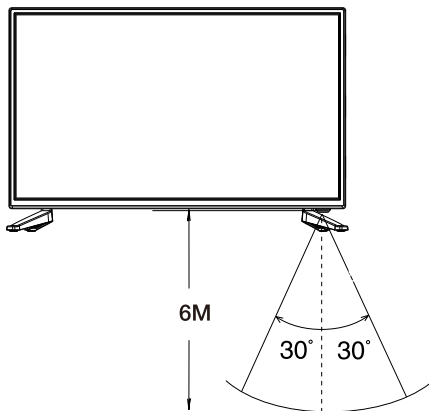

Learning about Remote Control

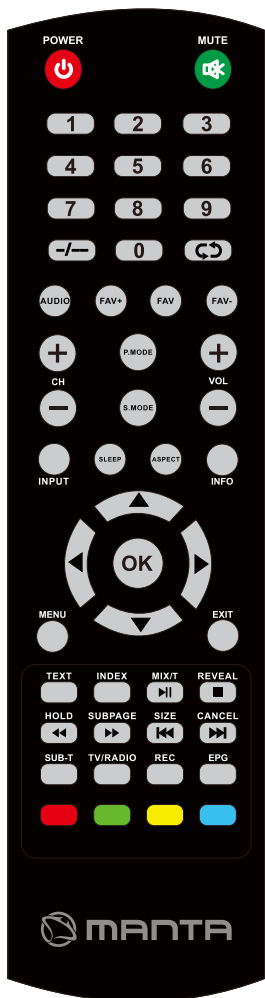

POWER: Press the TV on and standby.

MUTE: Press to mutes the sound.

NUMBER: Numeric buttons for direct channel access.

-/-- : Call up the program table.

↶ : go back to the last viewed channel .

AUDIO: Switch the audio channel in DVD or multimedia mode.

FAV: Press to display the favorite channel list which you stored before.

FAV+ or FAV-: Scans up or down through the current favorite channel list.

CHANNEL “+” “-”: Press to change the TV channels.

VOL “+” “-”: Press to increase or decrease the volume.

P.MODE: Press to select the picture mode.

S.MODE: Press to select the sound mode.

SLEEP: Press to select a preset time interval for automatic shut off.

ASPECT: Aspect Ratio .

INPUT: Accesses the available input channels, Use the arrows to highlight options, and press OK to select.

INFO : Displays the current input information.

◀▶▲▼ : Use to select on-screen menu items and change menu values.

OK: Enter and conform button.

MENU: Press to display the OSD menu.

EXIT: Exit the menu

TEXT: To enter Teletext mode

INDEX: To display the index page

MIX: TV and TXT picture are mixed together in transparent background.

REVEAL: Teletext mode-To reveal or hide the hidden words.

HOLD: Teletext mode-Hold current page which is displayed.

SUBPAGE: Sub coded page access.

SIZE: Change the size of display in Teletext mode.

CANCEL: To cancel the display.

⏮: PLAY/PAUSE

■:STOP

⏪: Fast return key

⏩:Fast forward key

⏮: Previous key

⏭: Next key

SUB-T: Select sub-title of media video file.

TV/RADIO: When watching a channel, allows you switch between TV and Radio modes.

REC: Presonal video record button.

EPG: Shows Electronic Program Guide.

Colour buttons: Channel Edit

TV OPERATION AND SYSTEM SETUP

SELECT INPUT SOURCE

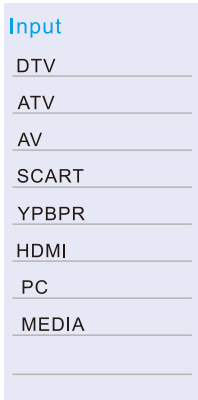

Press **INPUT** button to display the input source list;
Press **▲/▼** button to select the input source you want to watch;
Press **ENTER** button to enter the input source;

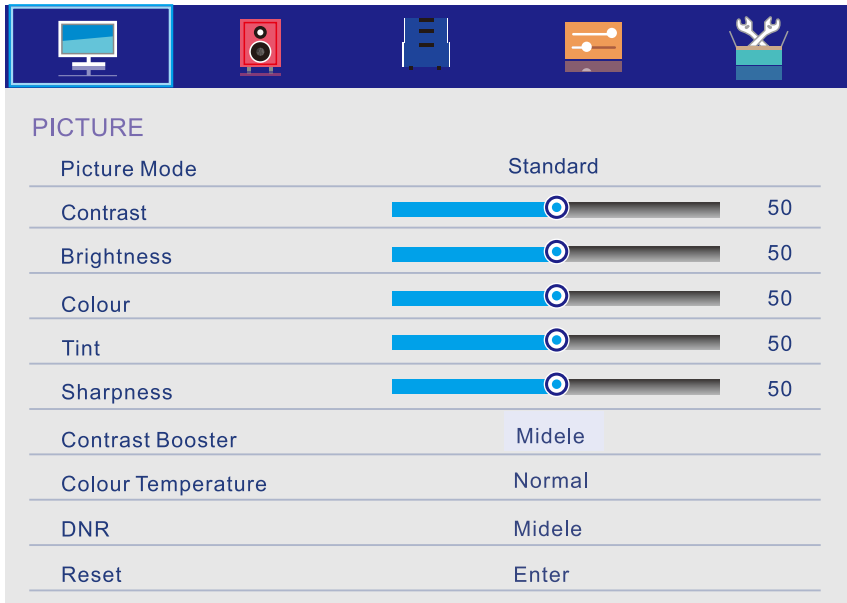

- Press **MENU** button to display the MAIN OSD MENU;

- Press ▲/▼ button to select the MENU you want;
- Press **ENTER** button or ► button to enter the sub menu, and press ◀ button to return back to the previous menu.
- Press ▲/▼ button to select the option and then press **ENTER** button or ► button to enter the submenu, press ◀/▶ button to adjust the value or press ◀/▶ button to select in the sub menu;
- You can press **MENU** button to save and return back to the previous menu, and press **EXIT** button to exit the entire menu.

Press **INFO** button on the remote control to display program information.



Function Description

Picture Menu

The picture is for a reference only; the actual item is the standard.

Press **TV MENU** button to display the main menu.

Press **▲/▼** button to select **Picture** in the main menu, and then press **ENTER** button to enter.

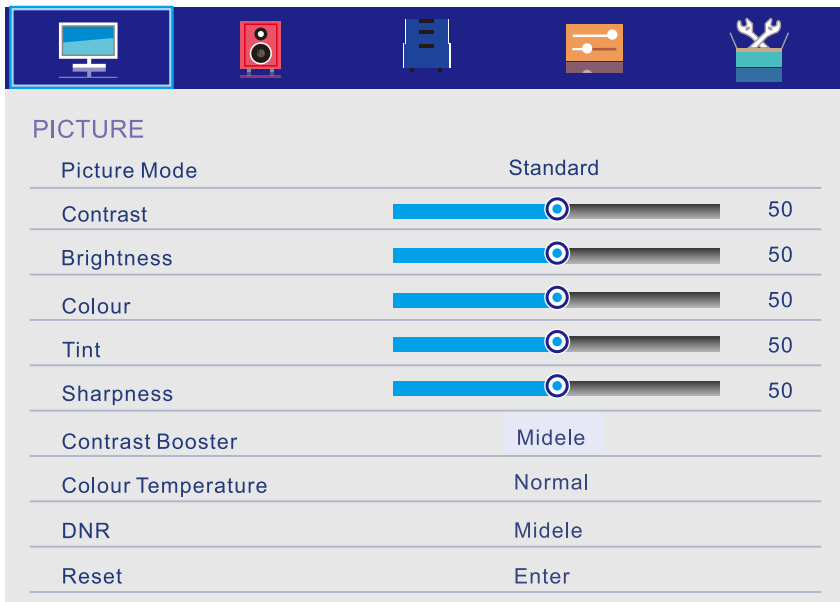

1. Press **▲/▼** button to select the option that you want to adjust in the Picture menu, and then press **ENTER** button or **▶** button to enter.
2. Press **◀/▶** button to adjust or press **▲/▼** button to select. And press **ENTER** button to select the sub menu.
3. After finishing your adjustment, press **MENU** button to save and return back to the previous menu, and press **EXIT** button to exit the entire menu.

Picture Mode

Press ▲/▼ button to select Picture Mode, then press **ENTER** button to enter and press ◀/▶ button to select.

You only can change the value of brightness, contrast, sharpness, color, when the picture is in User mode.

TIPS: You can press **P-MODE** button on the remoter control again and again to change the picture mode directly.



Contrast

Press ▲/▼ button to select Contrast, then press **ENTER** button to enter and press ◀/▶ button to adjust. Then press **MENU** button to return back the previous menu directly.

Brightness

Press ▲/▼ button to select Brightness, then press **ENTER** button to enter and press ◀/▶ button to adjust. Then press **MENU** button to return back the previous menu directly.

Colour

Press ▲/▼ button to select Colour, then press **ENTER** button to enter and press ◀/▶ button to adjust. Then press **MENU** button to return back the previous menu directly.

Tint

Press ▲/▼ button to select Tint, then press **ENTER** button to enter and press ◀/▶ button to adjust. Then press **MENU** button to return back the previous menu directly.

Sharpness

Press ▲/▼ button to select Sharpness, then press **ENTER** button to enter and press ◀/▶ button to adjust. Then press **MENU** button to return back the previous menu directly.

Contrast Booster

Press ▲/▼ button to select Contrast Booster, then press **ENTER** button to enter and press ◀/▶ button to select On or Off. Then press **MENU** button to return back the previous menu directly.

Colour Temperature

Press ▲/▼ button to select **Colour Temperature**, then press **ENTER** button to enter and ◀/▶ button to select Standard, Cool, Warm.

DNR

Press ▲/▼ button to select **DNR**, and then press **ENTER** button to enter and ◀/▶ button to select Off, Low, Middle, High.

Reset

Press ▲/▼ button to select **Reset**, then press **ENTER** button to enter the confirm menu, and then choose **OK** to reset the value.

SOUND Menu

The picture is for a reference only; the actual item is the standard.

Press **MENU** button to display the main menu.

Press **▲/▼** button to select **Sound** in the main menu, and then press **ENTER** button or **▶** button to enter.

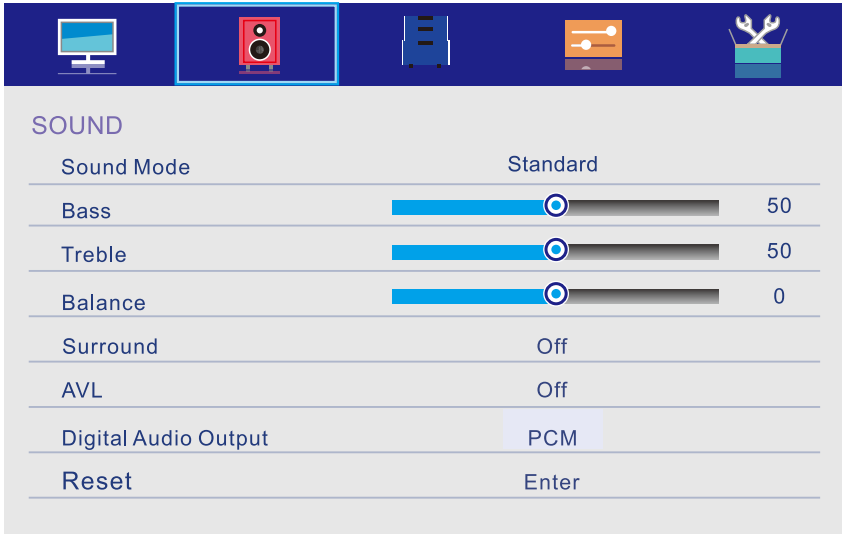

1. Press **▲/▼** button to select the option that you want to adjust in the Sound menu, then press **ENTER** button to enter.
2. press **◀/▶** button to adjust or press **▲/▼** to select, and press **ENTER** button to select submenu.
3. After finishing your adjustment, Press **MENU** button to save and return back to the previous menu, or press **EXIT** button to exit the entire menu.

Sound mode

Press **▲/▼** button to select **Sound mode**, and then press **ENTER** button to enter. And then press **◀/▶** button to select.

You can change the value of bass and treble, Balance and EQ, when the sound is in User mode.

TIPS: You can press **S-MODE** button on the remote control to change the Sound Mode directly.



Bass

Press **▲/▼** button to select Bass, then press **ENTER** or **▶** button to enter and press **◀/▶** button to adjust. It can only be adjusted under user mode. Then press **MENU** button to return

back the previous menu directly.

Treble

Press ▲/▼ button to select **Treble**, then press **ENTER** button to enter and press ◀/▶ button to adjust. It can only be adjusted under user mode Then press **MENU** button to return back the previous menu directly.

Balance

Press ▲/▼ button to select **Balance**, then press **ENTER** button to enter and press ◀/▶ button to adjust. Then press **MENU** button to return back the previous menu directly.

Surround

Press ▲/▼ button to select **Surround**, and then press **ENTER** button to enter and press ◀/▶ button to select ON or OFF.

AVL

Press ▲/▼ button to select **AVL**, and then press **ENTER** button to enter and press ◀/▶ button to select ON or OFF.

Digital Audio Output

Press ▲/▼ button to select **Digital Audio Output**, then press **ENTER** button to enter and press ◀/▶ button to select.

Then press **ENTER** button or ▶ button to enter and press ◀/▶ button to adjust, then press **MENU** button to return back the previous menu directly.

Reset

Press ▲/▼ button to select **Reset**, then press **ENTER** button to enter RESET menu.

APPLICATIONS

The picture is for a reference only; the actual item is the standard.

Press **MENU** button to display the main menu.

Press **▲/▼** button to select **APPLICATIONS** in the main menu, and then press **ENTER** button to enter.

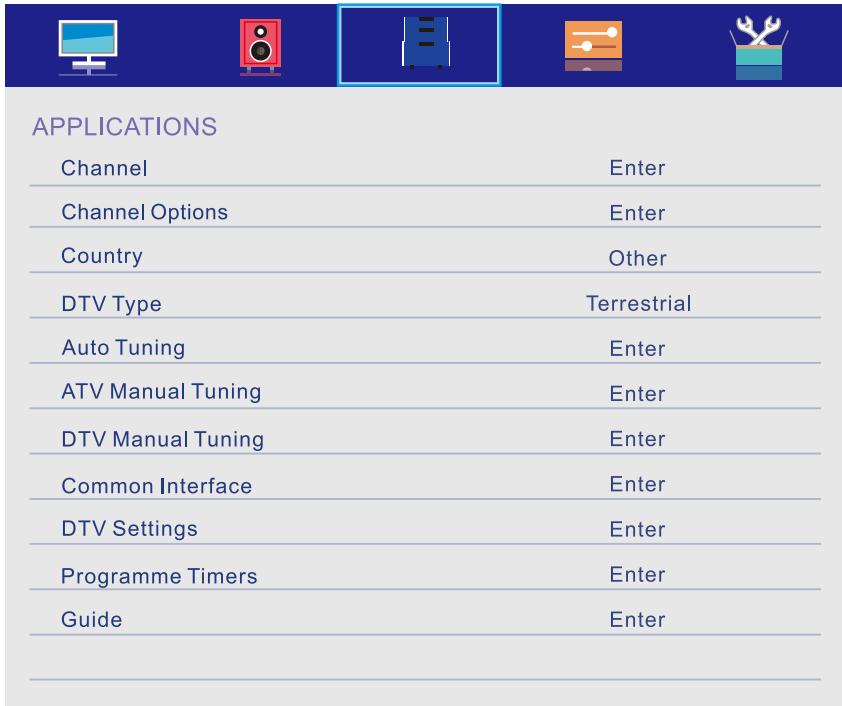

1. Press **▲/▼** button to select the option that you want to adjust in the **APPLICATIONS** menu, and then press **ENTER** button to enter.

2. Press **◀/▶** button to select and press **ENTER** button to select the sub menu.

3. After finishing your adjustment, press **MENU** button to save and return back to the previous menu, or press **EXIT** button to exit the entire menu.

Channel

Press ▲/▼ button to select **Channel**, and then press **ENTER** button to play the channel selected. The menu will appear as follows:



Key Description:

CH button: Press CH+ or CH- to turn the page.

RED button: Press this button to modify the channel number.

GREEN button: Press this button to move down the channel.

YELLOW button: Press this button to the order to restore the default channel.

GREEN button: Press this button to delete the channel selected.

0-9 button: Press these buttons to jump to the appropriate channel by inputting different channel number.

Channel Options

Press ▲/▼ button to select **Channel Options**, and then press **ENTER** button to the channel List menu. The menu will appear as follows:



Key Description:

CH button: Press CH+ or CH- to turn the page.

RED button: Press this button to set the favorites channels.

GREEN button: Press this button to lock the channel.

YELLOW button: Press this button to skip the channel, if the channels already skipped, press **YELLOW** button again will cancel skip.

Country

Press ▲/▼ button to select **Country**, and then press ◀/▶ button to select which area you stay.

DTV Type

Press ▲/▼ button to select **DTV Type**, then press ◀/▶ button to select.
(Available DTV Type: Cable, Terrestrial)

Auto Tuning

Press ▲/▼ button to select **Auto Tuning**, and then press **ENTER** button to enter
(When the System Lock is on, please input the PIN code to unlock).

Select to open the auto searching page, and press Enter button to start the scan.

DEFAULT CODE:0000

ATV Manual Tuning

Press ▲/▼ button to select **ATV Manual Tuning**, and then press **ENTER** button to start the scan.

DTV Manual Tuning

Press ▲/▼ button to select **DTV Manual Tuning**, and then press **ENTER** button to start the scan.

Common Interface

Press ▲/▼ button to select **Common Interface**, and then press **ENTER** button to display the CI slot Information.

DTV Settings

Press ▲/▼ button to select **DTV Settings**, and then press **ENTER** button to enter the sub menu.



User can set the subtitle and audio, local time settings, DST, LCN, 24hour audio description on this options.

Programmer Timers

Press ▲/▼ button to select **Programmer Timers**, and then press **ENTER** button to display the sub menu, and then press **ENTER** to set an appointment record. As follow:

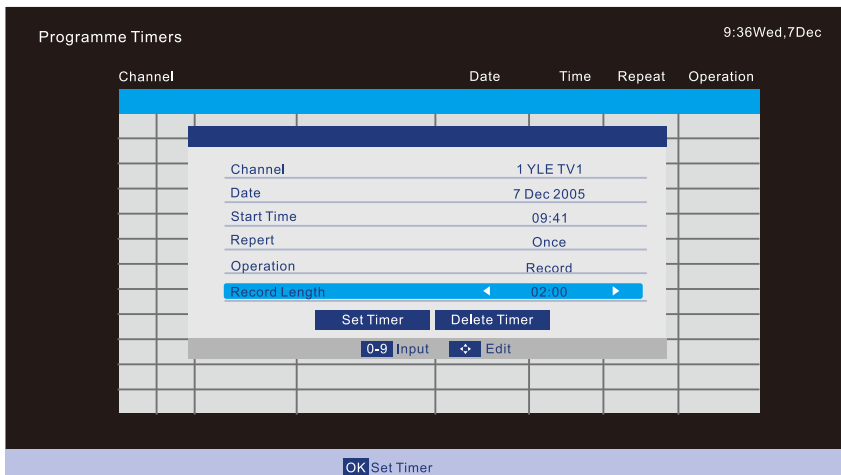

Press number keys and direction keys, user can set the channel, date, start time, repeat, operation and record length information on this menu.

When approaching the preset time, the screen will be appear a countdown to remind the user menu.

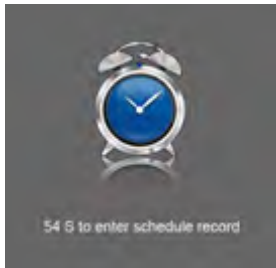

Guide

Press ▲/▼ button to select **Guide**, and then press **ENTER** button to display the EPG programmers list. As follows:

Guide	
◀ Ch1 YLE TV1 ▶	Movie/Drama 9:37 Wed, 7 Dec
07 Wed	08 Thu
09 Fri	10 Sat
11 Sun	12 Mon
13 Tue	14 Wed
09:15a - 10:03a	Sydämen asialla
10:05a - 10:13a	
10:13a - 10:29a	Koulu-tv: nain tehtiin Ullakkokomppania
10:30a - 10:58a	
11:00a - 11:04a	Tv-uutiset
11:05a - 11:26a	
11:30a - 11:58a	FST: Elämäntaito
11:58a - 12:02a	FST: Tate Modern: Eri ulottuvuudet
12:02p - 12:04p	FST: What's so good about Roald Dahl
12:15p - 12:26p	
12:30p - 12:43p	Koulu-tv: Minun sukupuuni

OK Play Display More Info CH+/- Page TV/Radio Prev Day Next Day Timers

User can also press the **EPG** Button on the remote to display the EPG programmers list.

PREFERENCES

The picture is for a reference only; the actual item is the standard.

Press **MENU** button to display the main menu.

Press ▲/▼ button to select **PREFERENCES** in the main menu, and then press **ENTER** or ► to enter.

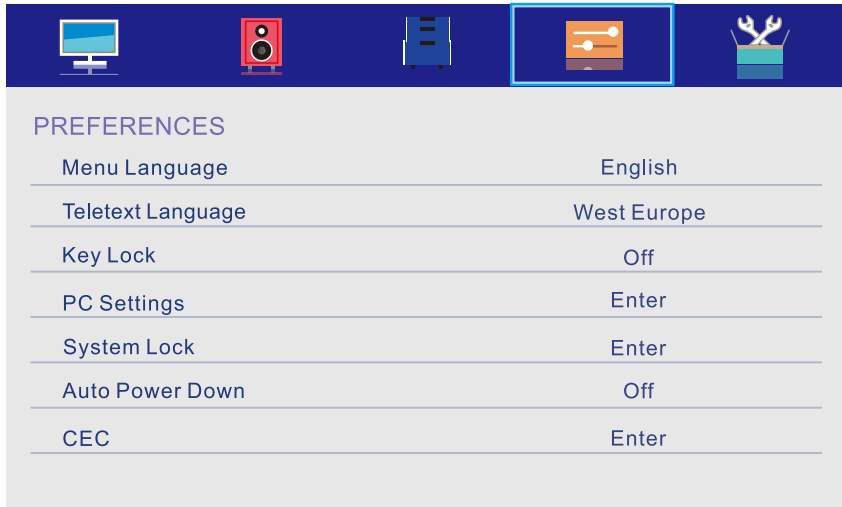

1. Press ▲/▼ button to select the option that you want to adjust in the **PREFERENCES** menu, then press **ENTER** to enter.
2. Press ◀/▶ button to adjust or press ▲/▼ button to select.
3. After finishing your adjustment, press **MENU** button to save and return back to the previous menu and press **EXIT** button to exit the entire menu.

Menu Language

Press ▲/▼ button to select **Menu Language**, then press **ENTER** or ► button to enter the sub menu, then press ▲/▼ button to select, then press **ENTER** or ► button to confirm.

Teletext Language

Press ▲/▼ button to select **Teletext Language**, then press **ENTER** or ► button to enter the sub menu, then press ▲/▼ button to select, then press **ENTER** or ► button to confirm.

Key Lock

Press ▲/▼ button to select **Key Lock**, then press **ENTER** button to enter and press ◀/▶ button to select ON or OFF.

PC Settings

Press ▲/▼ button to select **PC Settings**, then press **ENTER** to enter the sub menu, Then Press ► to enter, then press **ENTER** or ► to confirm. (When the PC signal is connected).

System Lock

Press ▲/▼ button to select **System Lock**, then press ◀/▶ button to select ON or OFF.

Auto Power Down

Press ▲/▼ button to select **Auto Power Down** and press ◀/▶ button to select Off/ 1 hour/ 2 hour/ 4 hour.

CEC

This setting is used to turn on/off HDMI CEC (Consumer Electronic Control).

SETUP

The picture is for a reference only; the actual item is the standard.

Press **MENU** button to display the main menu.

Press **▲/▼** button to select **Setup** in the main menu, then press **ENTER** to enter.



1. Press **▲/▼** button to select the option that you want to adjust in the **Setup** menu, then press **ENTER** or **▶** button to enter.
2. Press **◀/▶** button to adjust or press **▲/▼** button to select.
3. After finishing your adjustment, press **MENU** button to save and return back to the previous menu and press **EXIT** button to exit the entire menu.

OSD Timer

Press **▲/▼** button to select **OSD Timer**, and then Press **◀/▶** button to select. (Available OSD Timer: 10 S, 20 S, 30S, 40S, 50S, 60S, off), then press **ENTER** button to confirm.

Cinema

Press **▲/▼** button to select **Cinema**, and then Press **◀/▶** button to select. (Available Cinema: Auto, 4x3, Wide, Super Live), then press **ENTER** button to confirm.

Blue Screen

Press **▲/▼** button to select **Blue Screen**, then press **◀/▶** to select On or Off. Then press **ENTER** to confirm.

OSD Timer

Press ▲/▼ button to select **OSD Timer**, and then Press ◀/▶ button to select. (Available OSD Timer: 10 S, 20 S, 30S, 40S, 50S, 60S, off), then press **ENTER** button to confirm.

Cinema

Press ▲/▼ button to select **Cinema**, and then Press ◀/▶ button to select. (Available Cinema: Auto, 4x3, Wide, Super Live), then press **ENTER** button to confirm.

Blue Screen

Press ▲/▼ button to select **Blue Screen**, then press ◀/▶ to select On or Off. Then press **ENTER** to confirm.

Sleep Timer

Press ▲/▼ button to select **Sleep Timer**, and then Press ◀/▶ button to select. (Available Sleep Timer: 00:15, 00:30, 01:00, 01:30, 02:00, off), then press **ENTER** button to confirm.

Location

Press ▲/▼ button to select **Location**, and then Press ◀/▶ button to select Home or Store, then press **ENTER** button to confirm.

Quick Setup

Press ▲/▼ button to select **Quick Setup**, and then Press then press **ENTER** button to enter the sub menu, enter the password if locked, and then you can quickly make some basic settings of the TV. As follows:

Reset TV

Press ▲/▼ button to select **Reset TV**, and then press **ENTER** to enter the sub menu, enter the password if locked, and then you can restore factory settings.

Shop

Press ▲/▼ button to select Shop.

Multimedia

MEDIA OPERATION

The picture is for a reference only; the actual item is the standard.

Note: Before operation **MEDIA** menu, Plug in USB device or memory card, then press **SOURCE** button to set the Source to Media.

Press **▲/▼** button to select **MEDIA** in the **Source Menu**, and then press **ENTER** or **▶** to enter. You can also enter the Media by pressing **MEDIA** button on the remote control.

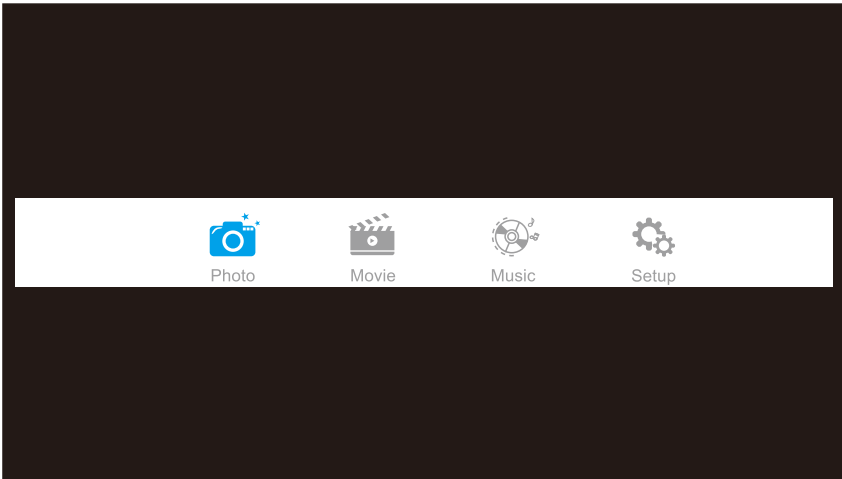

1. Press **▲/▼** button to select the option that you want to adjust in the **Media** menu, then press **ENTER** or **▶** button to enter.
2. Press **◀/▶** button to adjust or press **▲/▼** button to select.
3. After finishing your adjustment, press **MENU** button to save and return back to the previous menu and press **EXIT** button to exit the entire menu.

Photo

The picture is for a reference only; the actual item is the standard.

Press ◀/▶ button to select **Music** in the main menu, and then press **ENTER** button to enter.

Press **EXIT** button to return back to the previous menu.

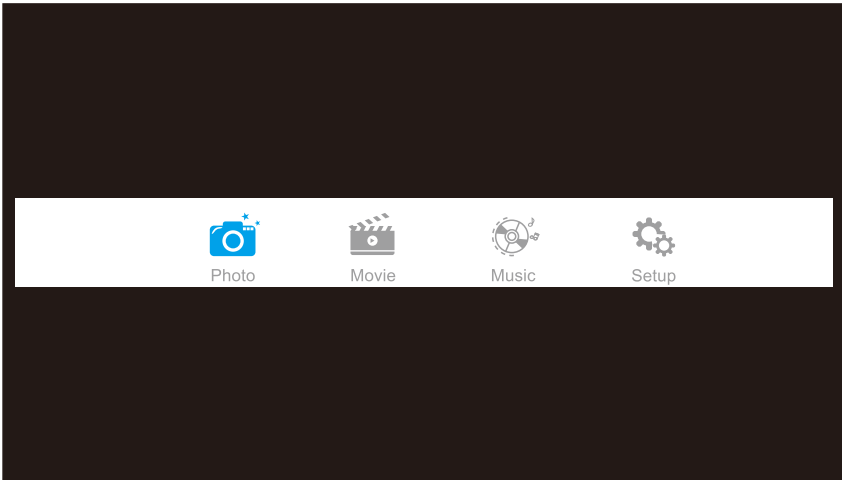

Press ▲/▼ to select the photos, press **ENTER** or ▶ || button to view.

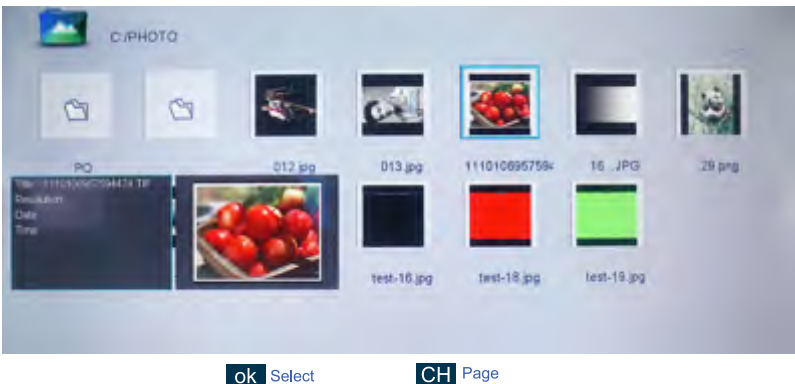

You can see the information of the current playing photo after press **INFO** button, then press ▶ || button to play or pause, you can see the playing state in the right.

Then press ▲/▼ or ◀/▶ button to rotate the picture.

Notes: Other menu and description are the same as that for Movie menu.

Movie

The picture is for a reference only; the actual item is the standard.

Press ◀/▶ button to select **Movie** in the main menu, then press **ENTER** button to enter.

Press **EXIT** button to return back to the previous menu.

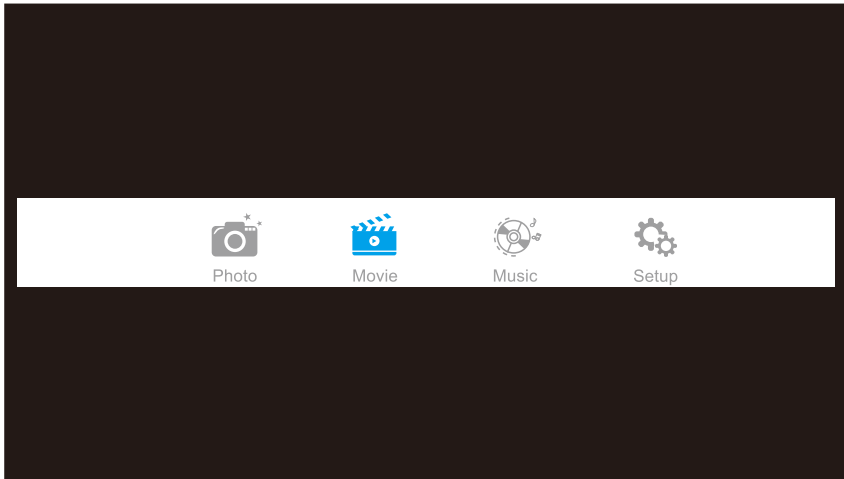

Press ▲/▼ button to select the folder that you want to view.

Press **ENTER** button to select the sub folder.



Press **ENTER** button or ▶|| button to play,

Press ■ button or **EXIT** button to stop playing.

Press the ◀ button to return back to previous page.

You can see the information of the current playing media at the first flew second or after press **INFO** button.

Music

The picture is for a reference only; the actual item is the standard.

Press ◀/▶ button to select **Music** in the main menu, and then press **ENTER** button to enter.

Press **EXIT** button to return back to the previous menu.

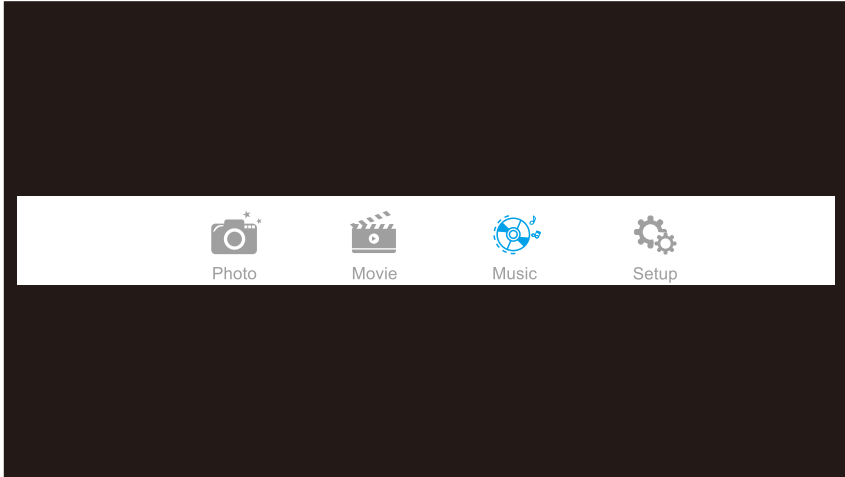

Press ▲/▼ button to select the sonny you want to listen, and then press **ENTER** or ▶ || or ▶ button to play.

Press ◀ button to return back to the previous menu.

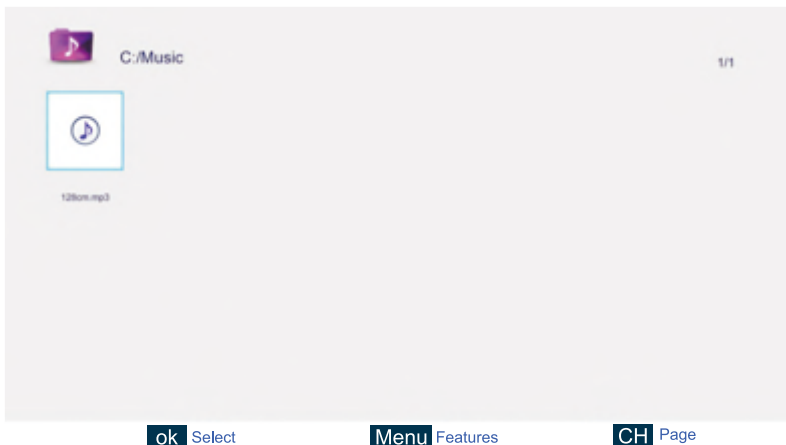

You can see the information of the current playing sonny at the left of the menu.

Setup

The picture is for a reference only; the actual item is the standard.

Press ◀/▶ button to select **Setup** in the main menu, and then press **ENTER** button to enter.

Press **EXIT** button to return back to the previous menu.

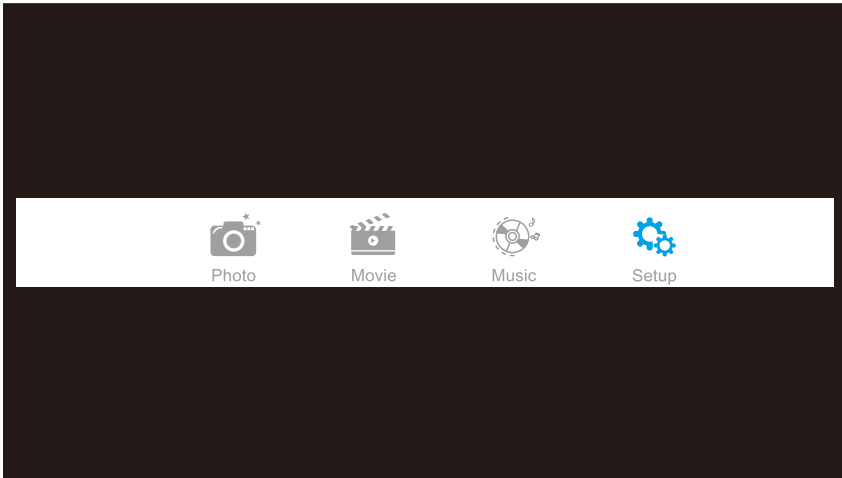

Press ▲/▼ button to select the option, and then Press ◀/▶ button to select it on or off.

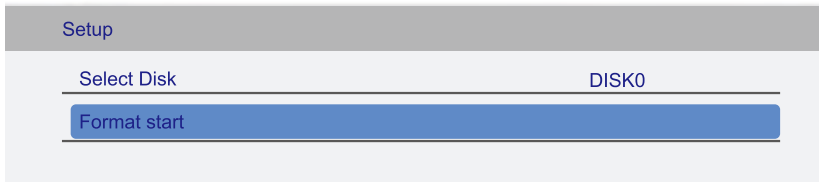

How to use Record

The HK-RTD2957 support two type to record :

- A、 Direct Record
- B、 Subscribe Record

Direct Record.

1. In the DTV source,you can start record function by press the “REC” key while program playing. Before that, you have to make sure the USB storage device is inserted and the device checking and Initialization is done.

If you press “REC” key when there’s no USB storage device inserted, the prompt window will appear as follow.



If you press “REC” key during the device checking and Initialization, the prompt window will show black screen about 2s.when the TV is recording, it will appear the recording menu.



2. After record started, you can select the items for the functions:

PLAY/PAUSE/STOP/AB/FF/FR/PRVE/NEXT. You can see the detail info by the record menu.

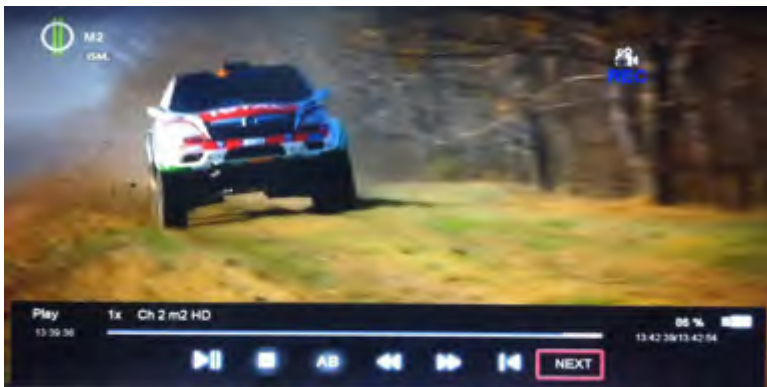

PLAY/PAUSE: you can set the play mode PLAY/PAUSE;

STOP: you can stop the recording, it will appear the menu for check whether to stop the recording.

AB: you can set two point for play the record file from A to B.

FF/FR: you can set the play mode FF/FR;

PRVE/NEXT: you can play the record file to PRVE/NEXT 30s.

3. After record started, you can press the button of PLAY/FF/FR/PRVE/NEXT on the RC ,you can play the record file by PALY/PAUSE/FF/FR/PRVE/NEXT/STOP.

4. You can press "STOP" key to stop record function after confirm.

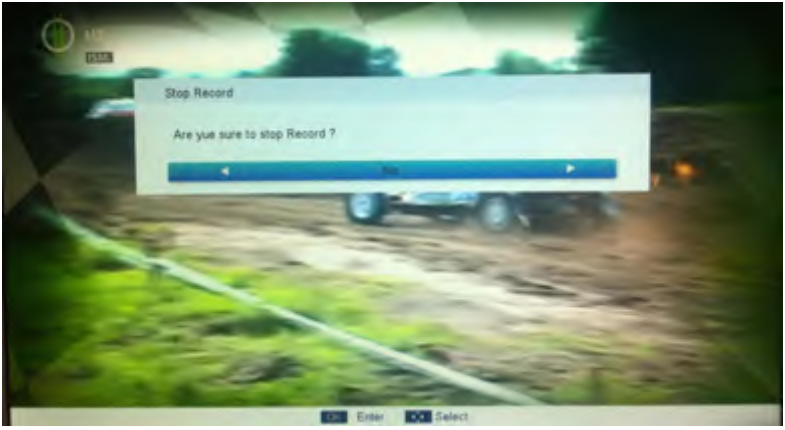

Subscribe Record

1. In the DTV source, you can enter the Timer menu set the Subscribe Record。 Press the “ENTER” key to add the record task.

The Way: Main menu--->APPLICTIONS--->Programme Timers---> Programme Timers

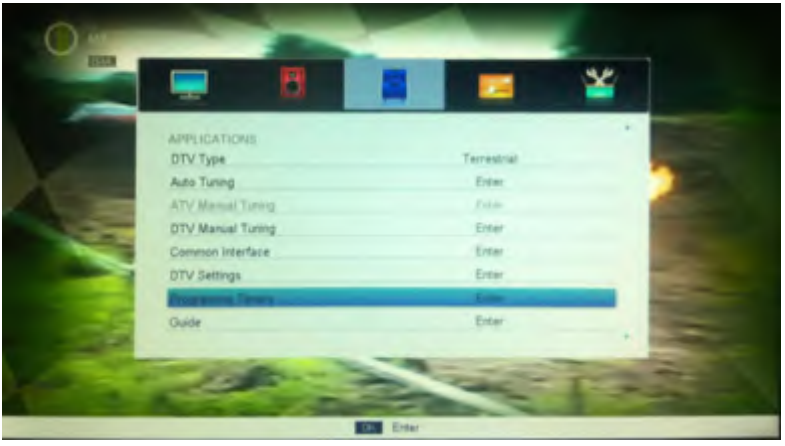



Note: Record function will stop when there's no space left on the USB storage device.

1. In the DTV source, you can start timeshift function by press the “PLAY/PAUSE” key while program playing. Before that, you have to make sure the USB storage device is inserted and the device checking and Initialization is done.

If you press “PLAY/PAUSE” key when there’s no USB storage device inserted, the prompt window will appear as follow.



If you press “PLAY/PAUSE” key during the device checking and Initialization, the prompt window will appear as follow.

If you press “PLAY/PAUSE” key during the device checking and Initialization, the prompt window will show black screen about 2s. when the TV is timeshifting, it will appear the timeshift menu.



2. After timeshift started, you can select the items for the functions: PLAY/PAUSE/STOP/AB/FF/FR/PRVE/NEXT. You can see the detail info by the timeshift menu.



- PLAY/PAUSE: you can set the play mode PLAY/PAUSE;
 - STOP: you can stop the recording, it will appear the menu for check whether to stop the recording.
 - AB: you can set two point for play the record file from A to B.
 - FF/FR: you can set the play mode FF/FR;
 - PRVE/NEXT: you can play the record file to PRVE/NEXT 30s.
3. After record started, you can press the button of PLAY/FF/FR/PRVE/NEXT on the RC ,you can play the record file by PALY/PAUSE/FF/FR/PRVE/NEXT/STOP.
4. you can press "STOP" key to jump to the realtime broadcast of the program, and another press of "STOP" key, you can stop timeshift function after confirm.

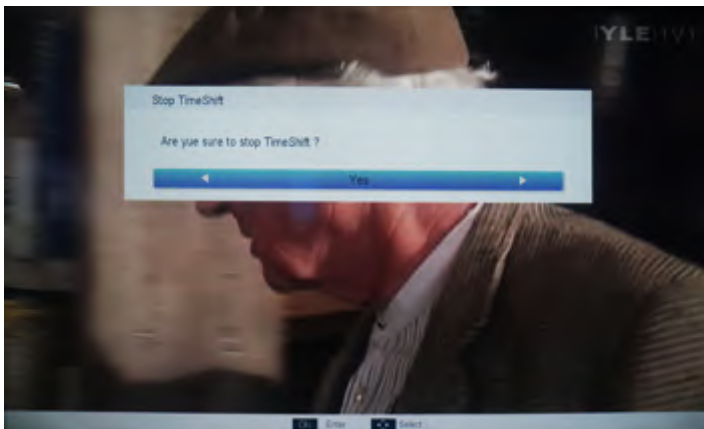

Note: Timeshift function will stop when there's no space left on the USB storage device.

Help

No Power	Check the AC cord of TV is plus in or not. If still no power, please pull out the plug and replug in after 60 seconds. And open the TV again
Signal receive not properly	<ul style="list-style-type: none"> ● To cause double image or phantom if there has high building or high mountain round TV. You can adjust image effect by manually operation: consult instruction of vernier regulation or change the direction of external antenna. ● If you use the indoor antenna . under certain circumstance , receive will be more difficult . So you can change the direction of the antenna to adjust the image effect . If can't change image receiving effect either , you have to use external antenna.
No picture	<ul style="list-style-type: none"> ● Check the antenna at the back of TV is connected properly or not. ● Try to select other channels and check whether the TV problem itself or not
but, Video is ok without audio	<ul style="list-style-type: none"> ● Increase the volume. ● Check the TV is in mute mode or not , and please press the mute button to make sound resume.
Audio is ok, but color error or no picture.	<ul style="list-style-type: none"> ● Increase contrast and brightness.
snow statics picture and noise	<ul style="list-style-type: none"> ● Check the antenna at the back of TV is connected or not.
Level broken line	<ul style="list-style-type: none"> ● vacuum, such as hair drier, Maybe has electrical appliance interfere- please turn off these kinds of electrical appliance, cleaner and so on.
Image or-Dual "simulacrum" The TV no response with the Remote.	<ul style="list-style-type: none"> ● Perhaps the location for the antenna is not good. Use the tall beamed antenna can be improved quality of the display image. ● Operate the remote direct to the remote sensor on the TV. If still no response for the TV, please check if the plastic bag on the remote take or not. And check if the location for the battery is correct. Change the new battery. ● The TV will shift to the STAND BY if no response from the remote in the few minutes.
.NO Video In (PC Mode)	<ul style="list-style-type: none"> ● Please check if the display cable connect to the VGA correcte . ● Please check if there has the bend on the display cable.
Vertical twinkling (PC Mode)	<ul style="list-style-type: none"> ● Enter the main menu, Use the clock regulator for the Video display noise to eliminate the vertical line.
horizontal ripping (PC Mode)	<ul style="list-style-type: none"> ● Adjust the Audio sound horizontal in the main menu to clear the horizontal ripping line.
The screen is too bright or too dark (PC Mode)	<ul style="list-style-type: none"> ● Adjust the contrast ratio or brightness in the main menu.
PC Function no response	<ul style="list-style-type: none"> ● Check the computer setting in the state of compatible display resolution
Ripping line in RCA connecting	<ul style="list-style-type: none"> ● Please use good quality connecting cable.
Problem still exist	<ul style="list-style-type: none"> ● Unplug the power cable and wait for 30 seconds, then connect. If there is some problem with our TV, do not repair it by yourself, please contact with the customer service center.

There will be complete picture and the brightness will come down if the TV is in: Note So please do not keep the TV in a state of same, the static picture for too long time Menu or same picture that has much difference in brightness and contrast ratio for too long time.

Product fiche

LED220Q7

- Supplier's name: Manta S.A.
- Supplier's model: LED220Q7
- Energy efficiency class: A
- Visible screen diagonal in centimetres and in inches: 55cm;22"
- On-mode power consumption: <20 W
- Annual energy consumption: 29 kWh/year
- Standby and off-mode power consumption: <0,5 W
- Screen resolution in physical horizontal and vertical pixel count: 1920x1080

Note!

Product design and Technical parameters may be change without notice. This mainly concerns parameters technical, software and user manual present. User's Manual is a general orientation on service product. Manufacturer and distributor do not assume any responsibility as compensation for any inaccuracies errors in the descriptions appearing in this user manual.

Model	Unit Dimension(unit:mm)	Screw Dimension
LED220Q7	VESA100x100	M4 Screws, length 6mm x 4pcs

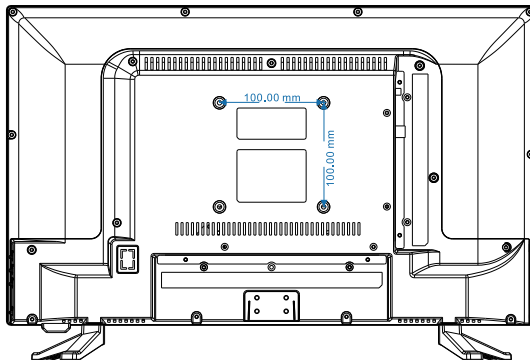

Note:

- The wall mount is not contained in the accessories sold with television. We only provide the installing specifications but not the wall mount itself. If you need the mount, please consult with the local dealer for a VESA wall mount.
- We strongly suggest to set the wall mount with equipments of specification we ordered. If not, inappropriate installing may cause damage to device or people.