

 **omni**charge™

Omni 20c+ **Manual**

www.omnicharge.co

POWER YOUR NEXT ADVENTURE

For more information visit our **support** page at www.omnicharge.co/support

BEFORE USING

Calibrate the battery

To make sure the battery percentage reading is correct, make sure to calibrate the battery within the first seven days of receiving the product.

It's easy to do. Follow these steps:

1. Fully discharge Omnicharge until the screen turns off. Press the Power Button and you should see an empty battery icon on the screen.



2. Fully charge your Omnicharge to 100% to finish the calibration.

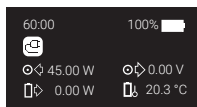

Note: The Omnicharge battery needs to be recharged at least every 6 months to avoid over depletion. Failure to do so can cause the battery to malfunction and is not covered by warranty.

PORTS AND BUTTONS

Note: For optimal wireless charging, place phone horizontally towards the back of the Omnicharge.

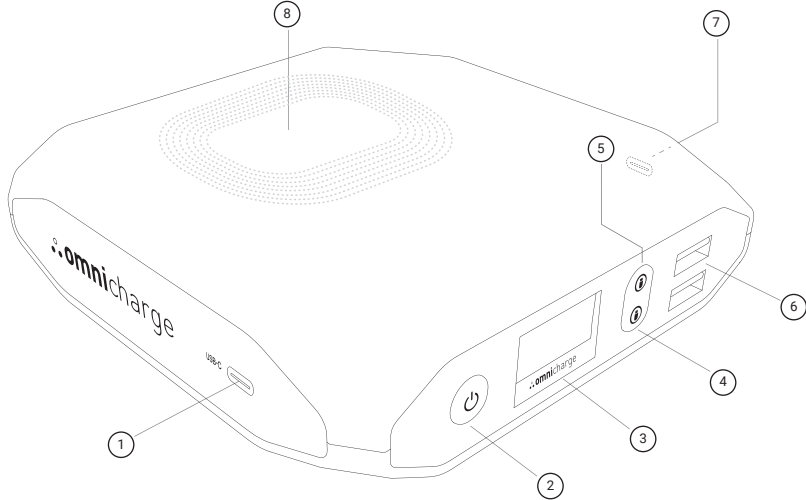





1. 60W USB-C port
2. Power and Menu Button
3. OLED Screen
4. USB Hub Button





5. USB-C Output Button
6. Quick Charge USB (QC 3.0 Compatible)
7. 100W USB-C port
8. Wireless Charging

BUTTON FUNCTIONS

PRIMARY CONTROLS

-  • Long press to power on
 -  • Long press to power off
 -  • On/Off USB-C ports
 -  • On/Off Hub Mode
-

MENU CONTROLS

-  • Double press to enter the menu
 -  • Quick press to select
 -  • Move Up
 -  • Move Down
-

SCREEN

OLED screen with real time metrics

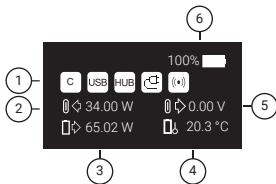

1. Status Icons
2. USB-C port 1 input(w) output(v)
3. Battery Power Output (watts)
4. Battery Temperature
5. USB-C port 2 input(w) output(v)
6. Battery Percentage

Note: When you are pass-through charging, the battery output field will show a lower value and can even show 0W output, since the output field is showing how much power is output from the battery and not how much is output from the port.

SCREEN ICONS



USB-C OUTPUT

USB-C ports are turned on.



USB-A OUTPUT

USB-A ports are turned on.



RECHARGING

Omni 20 USB-C is being recharged.



OPTIMAL CHARGING

Omni 20 USB-C is being charged at maximum power (45W).



LOW TEMPERATURE PROTECTION

Battery's temperature is too low and the charging circuit is shut off.



OVERHEATING PROTECTION

Battery temperature is too high. Omni 20 USB-C will limit or cut off its input and output power.



LOW POWER PROTECTION (Only under pass-through charging)

Omni 20 USB-C will cut off the output power and only allows input when the battery level is low.



OVERPOWER PROTECTION

Your device is drawing too much power. Omni 20 USB-C will limit or cut off its output power.



OVERVOLTAGE PROTECTION

Input voltage is exceeding its limit. Input charging circuit is shut off.



BATTERY LIMITING FUNCTION

Battery Limit for charging/discharging is activated.



HUB

HUB mode is activated.

MENU NAVIGATION

1. SCREEN OFF TIMER

Set the screen auto shut-off time here. The default setting is 5 min.

2. AUTO SHUT DOWN

Set the power auto shut-off time here. The default setting is 5 min.

3. TEMPERATURE

Choose whether your temperature is displayed in celcius or fahrenheit

4. BUTTON LIGHT

Choose whether the button lights are on or off. The default setting is on.



MENU NAVIGATION

4. BUTTON LIGHT

Choose whether the button lights are on or off. The default setting is on.

5. ABOUT

Find the model name, capacity, firmware version, and serial number information here.



RECHARGE THE OMNI 20 USB-C

USB-C port max input: 45W

Fully recharge in 3 hours

From either USB-C port:

Plug in a USB-C wall charger and it will start recharging the Omni 20 USB-C.



HOW TO USE HUB MODE

Use the Omni 20 USB-C as a USB hub and transfer files between your smartphones, flash drives, cameras or laptops

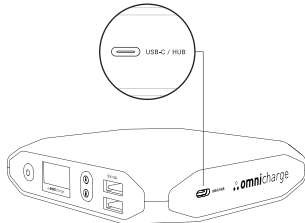

1. Connect the USB-C/HUB port (on the right side) to a USB-C port on your laptop.

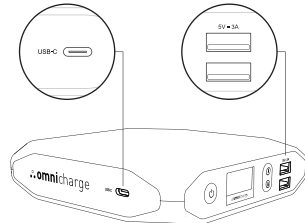

2. Initiate HUB mode by short pressing the HUB button (bottom button), and a HUB icon will appear on the screen. The secondary USB-C port (left side) and the 2 USB-A ports can be used to transfer files from smartphones, flash drives, cameras or other standard USB-A or USB-C devices.

USB-C PORTS



Left USB-C port max output: 60W
Right USB-C port max output 100W

Short press the USB-C output button to turn the USB-C ports on/off.

Note: Make sure the Omni 20 USB-C is powered on before plugging in your device. Otherwise your device will recharge the Omni 20 USB-C

USB-A PORTS



USB Port 1: 18W, QC 3.0 Compatible
USB Port 2: 18W, QC 3.0 Compatible

★ Combined USB-A/USB-C ports max output: 100W

Power any device.



Action Cameras



Gaming Devices



Smartphones



Tablets



Laptops



And more

TECHNICAL SPECIFICATION

GENERAL

Weight: 1.1 lbs (506 g)

Dimension: 5.0"x 4.8"x 1.1"(12.7 x 12.2 x 2.7 cm)

USB-C

Bidirectional Input/output charging

Input: USB-PD, 5V~20V, up to 3A, 45W max

Output Left USB-C Port: 5V/3A, 9V/3A, 12V/3A, 15V/3A, 20V/3A, up to 3A, 60W max

Output Right USB-C Port: 5V/3A, 9V/3A, 12V/3A, 15V/3A, 20V/3A, up to 5A, 100W max

USB-A Output

Port1: QC 3.0, 5V/3A, 9V/2A, 12V/1.5A, 18W Max

Port2: QC 3.0, 5V/3A, 9V/2A, 12V/1.5A, 18W Max

WIRELESS CHARGING

Output: 10W

CAPACITY

6 cells, 71Wh (20,100mAh at 3.6V)

OPERATING ENVIRONMENT

Temperature 0°C-40°C

Humidity 30-70%

Altitude ≤2000m

MADE IN CHINA

© 2019 Omniccharge.

❖ **omni**charge™ is a trademark of Omniccharge Inc.

THANK YOU

www.omnicharge.co

CUSTOMER SUPPORT

All Omnicharge products have gone through quality inspection. If you find your Omnicharge or any Omnicharge accessory is experiencing or demonstrating any abnormal behavior, immediately stop all product use and contact us at support@omnicharge.co.

FOLLOW US



<https://www.facebook.com/omnicharge>



<https://www.instagram.com/omnicharge>



<https://www.youtube.com/c/omnicharge>



https://twitter.com/omni_charge

THANK YOU

www.omnicharge.co

© 2017 Omnicharge.

Omnicharge is a trademark of Omnicharge Inc.